

# we:boost

## Installation Guide

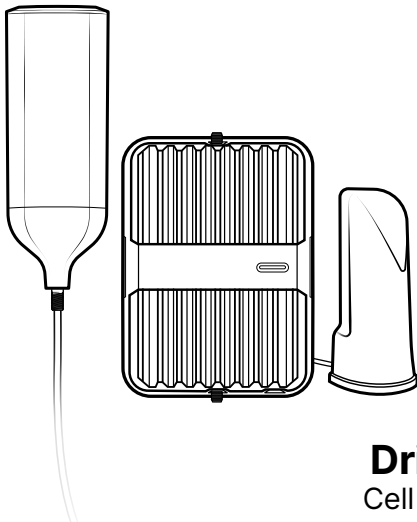

### **Drive Reach RV** Cell Signal Booster Kit

Use our **weBoost App** to guide you through the installation. See inside page for more details.

# Download the weBoost App

Use our app to guide you through setting up a weBoost cell phone signal booster in your home, business, or vehicle. Boost every network, including 5G, right away.



# Index

Package Contents . . . . .	1
Installation Overview . . . . .	2
STEP 1 Select Mounting Location & Assemble the Outside Antenna . . . . .	3
STEP 2 Select Inside Antenna Location. . . . .	8
STEP 3 Booster Location & Connect Coax Cables . . . . .	9
STEP 4 Connect Power Supply to Booster . . . . .	11
Booster Light Patterns . . . . .	12
Troubleshooting . . . . .	14
Safety Guidelines. . . . .	16
Antenna Info . . . . .	18
Specifications. . . . .	19
Warranty . . . . .	20

## Package Contents



Drive Reach  
Signal Booster &  
Bracket

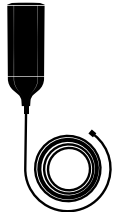

Outside  
Antenna & 25'  
RG-6 Cable



Inside  
Antenna



Power  
Supply

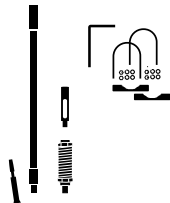

13 in. Mast Extension,  
Side-Exit Adapter,  
Spring, L-Bracket  
Mount & Thread  
Lock Pack



## Installation Overview

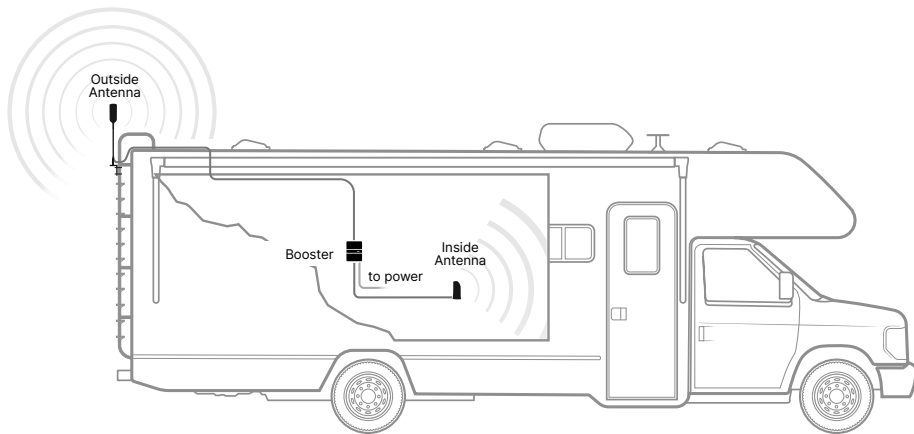

## STEP 1 Select Mounting Location & Assemble the Outside Antenna

Determine where you want the outside antenna on your RV. **Mount outside antenna** to a ladder or pole so that the entire outside antenna is above the roof line of the RV and clear of other metal obstructions.

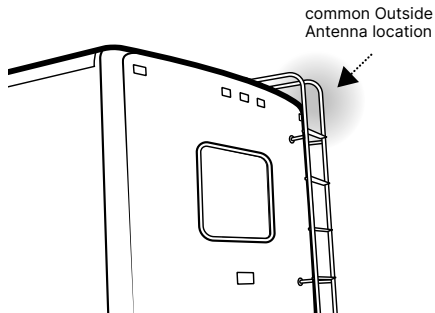

### Important

NOTE: Keep in mind to stay below the maximum height limit allowed by law, which varies from state to state (generally 14' in western states and 13'6" in eastern states).



## (STEP 1 cont.)

After determining outside antenna mounting location and assembly is the correct height, **insert coax cable through mast extension (mast can be used optionally), then through side-exit adapter.**

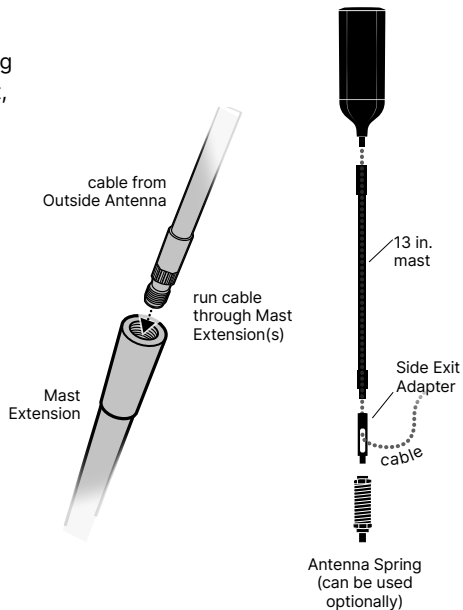

(STEP 1 cont.)

**Apply the thread locker** precisely to thread points only (not plastic body of antenna).

**Screw mast onto antenna.**

**Connect 25 foot cable to outside antenna cable.** Heat shrink tube can be applied to the connection (optional).

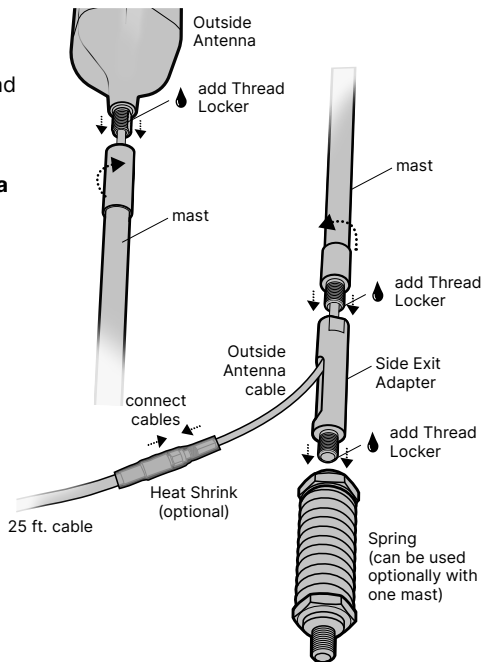

## (STEP 1 cont.)

**Mount outside antenna. L-bracket mount and hardware is provided** to mount to ladder or pole. If installing with spring, the side exit adapter must be used.

NOTE: Outside antenna location must be within reach of the booster with the 25' coax cable. The system performs best with maximum vertical and horizontal separation.

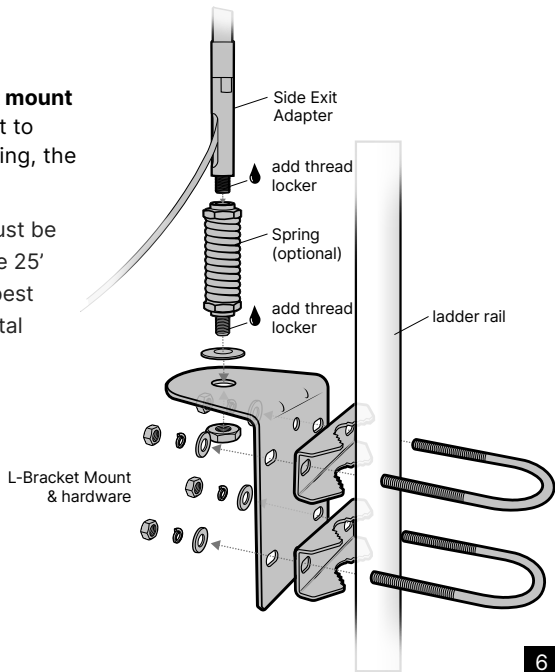

## (STEP 1 cont.)

### Route cable into the RV.

**Option A:** Using existing cable entry point.

**Option B:** Through the slider on your RV  
(using the slider gasket as a seal).

NOTE: We recommend doing a **'soft install'** before drilling the hole. Set up the system by routing the cable through an open door or window, completing the setup instructions, verifying the system works as desired, and then drilling the hole.

**Option A**

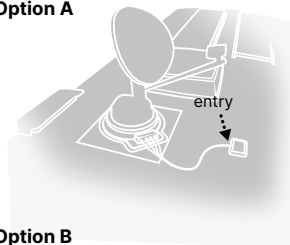

**Option B**

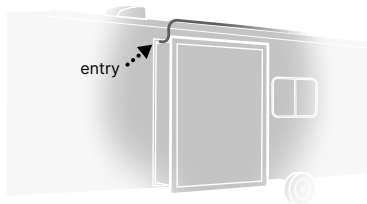

## STEP 2 Select Inside Antenna Location

Place **inside antenna** where stronger signal is desired in the RV and make sure connection to 13 foot cable is secure. Finger tighten only.

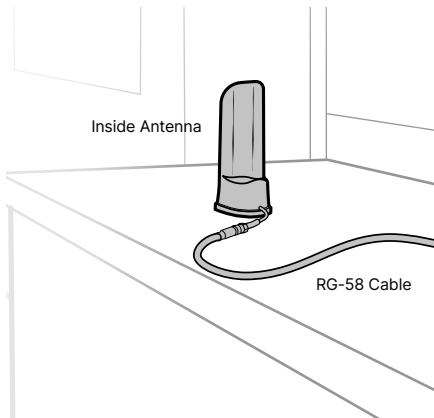

## STEP 3 Booster Location & Connect Coax Cables

**Find a accessible location** to place the booster that has good air flow. The booster includes a mounting bracket that provides different mounting options. It can be secured with Velcro® strips, screws or zip ties. Securing the booster with Velcro® behind or under the seat is a good option.

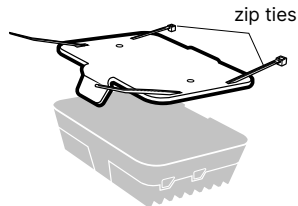
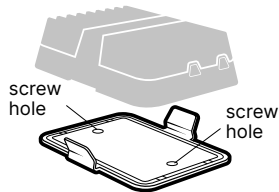
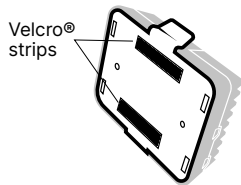



## (STEP 3 cont.)

**Connect the coax cable** from the outside antenna to the port labeled “Outside Antenna” on the booster. Then **connect the cable** from the inside antenna to the port labeled “Inside Antenna” on the booster.

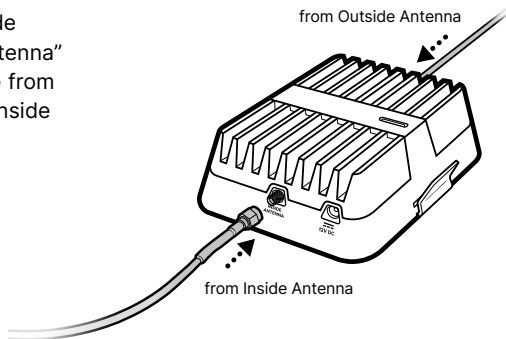

## STEP 4 Connect Power Supply to Booster

Connect the power supply cord to the end of the booster, labeled **"12V DC"**, and connect into a 12V wall plug. Enjoy your boosted signal!

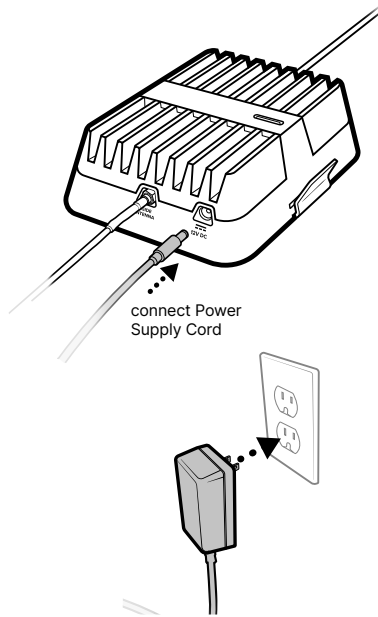

## Booster Light Patterns

### SOLID GREEN

This indicates that your Drive Reach booster is functioning properly and there are no issues with installation.

### SOLID RED

Band has shutoff. This is due to a feedback loop condition called oscillation. This is a built in safety feature that causes a band to shut off to prevent harmful interference with a nearby cell tower. Refer to Troubleshooting section.

### BLINKING RED, THEN SOLID GREEN

This indicates that one or more of the booster bands has reduced power due to a minor feedback loop condition called oscillation. This is a built in safety feature to prevent harmful interference with a nearby cell tower. If you are already experiencing the desired signal boost, then no further adjustments are necessary. If you are not experiencing the desired boost in coverage then refer to the Troubleshooting section.

### LIGHT OFF

If the Drive Reach signal booster's light is off, verify your power supply has power.

## (Booster Light Patterns cont.)

NOTE: The signal booster can be reset by disconnecting and reconnecting the power supply.

After troubleshooting, you must initiate a new power cycle by disconnecting and then reconnecting power to the booster.

## Troubleshooting

### FIXING BLINKING OR RED LIGHT ISSUES

**This section is only applicable if the light on the booster is red or blinking red and you are not experiencing the desired signal boost.**

- 1 Unplug the booster's power supply.
- 2 Relocate the inside and outside antenna further from each other. The objective is to increase the separation distance between them, so that they will not create this feedback condition discussed before.
- 3 Plug power supply back in and ensure switch is in ON position.
- 4 Monitor the indicator light on your booster. If, after a few seconds of 'power on', a solid or blinking red light appears, repeat steps 1 through 3. Increase the separation distance until the condition is corrected and/or desired coverage area is achieved.  
Note: Horizontal separation of the two antennas typically requires a shorter separation distance than vertical separation.

If you are having any difficulties while testing or installing your booster, contact our weBoost Customer Support team for assistance (1-866-294-1660).

## (Troubleshooting cont.)

### FREQUENTLY ASKED QUESTIONS

#### **How can I contact customer support?**

Customer Support can be reached Monday through Friday by calling 1-866-294-1660, or through our support site at [support.weboost.com](http://support.weboost.com).

#### **Why do I need to create distance between the outside antenna and inside antenna?**

Antennas connected to a booster create spheres of signal. When these spheres overlap, a condition called oscillation occurs. Oscillation can be thought of as noise, which causes the booster to scale down its power or shut down to prevent damage. The best way to keep these spheres of signal from overlapping is to maximize separation between the inside and outside antennas.

---

 1-866-294-1660

 [www.weboost.com](http://www.weboost.com)

 [support@weboost.com](mailto:support@weboost.com)

---

## Safety Guidelines

Use only the power supply provided in this package. Use of a non-weBoost product may damage your equipment.

Connecting this signal booster directly to the cell phone with use of an adapter will damage the cell phone.

RF Safety Warning: Any antenna used with this device must be located at least 8 inches (20 cm) from all persons.

AWS Warning: The Outside Antenna must be installed no higher than 31 feet 9 inches (10 meters) above ground.

### **This is a CONSUMER device.**

---

**BEFORE USE**, you **MUST REGISTER THIS DEVICE** with your wireless provider and have your provider's consent. Most wireless providers consent to the use of signal boosters. Some providers may not consent to the use of this device on their network. If you are unsure, contact your provider.

In Canada, **BEFORE USE** you must meet all requirements set out in ISED CPC-2-1-05.

You **MUST** operate this device with approved antennas and cables as specified by the manufacturer. Antennas **MUST** be installed at least 20 cm (8 inches) from (i.e., **MUST NOT** be installed within 20 cm of) any person.

You **MUST** cease operating this device immediately if requested by the FCC (or ISED in Canada) or licensed wireless service provider.

**WARNING.** E911 location information may not be provided or may be inaccurate for calls served by using this device.

(Safety Guidelines cont.)

**FOR MORE INFORMATION ON REGISTERING YOUR SIGNAL BOOSTER WITH YOUR WIRELESS PROVIDER IN THE U.S., PLEASE GO TO THE LINK BELOW:**

<https://www.weboost.com/carrier-registration>



## Antenna Info

The following accessories are certified by the FCC to be used with the Drive Reach Booster.

This radio transmitter 4726A-460061 has been approved by Innovation, Science and Economic Development Canada to operate with the antenna types listed below, with the maximum gain indicated. Antenna types not included in this list that have a gain greater than the maximum gain indicated for any type listed are strictly prohibited for use with this device.

	BAND 12/17	BAND 13	BAND 5	BAND 4	BAND 25/2
Outside antenna maximum permissible antenna gain (dBi) 50Ω	1.2	1.2	1.1	0.8	0.4
Inside antenna maximum permissible antenna gain (dBi) 50Ω	2.1	2.6	3.20	2.1	2.7

### MOBILE INSIDE ANTENNA KIT OPTIONS

Kit #	Coax Type	Ln(ft)	Antenna Type	Ω
314401	LMR-100	10	Slim Low Profile SMA	50
311160	RG-58	13	Desktop	50

### MOBILE OUTSIDE ANTENNA KIT OPTIONS

Kit #	Coax Type	Ln(ft)	Antenna Type	Ω
311216	LMR-195	10	Mini-Mag SMA	50
311229	RG-58	15	Trucker	50
311230	RG-6	25	RV OTR	75
314405	RG-58	14	NMO	50

# Specifications

Drive Reach Cell Signal Booster					
<b>Model</b>	460061				
<b>FCC</b>	PWO460061				
<b>IC</b>	4726A-460061				
Connectors	SMA-Female				
Antenna Impedance	50 Ohms				
Frequency	698-716 MHz, 728-756 MHz, 777-787 MHz, 824-894 MHz, 1850-1995 MHz, 1710-1755/2110-2155 MHz				
Power output for single cell phone (Uplink) dBm	<b>700 MHz B12/17</b> 25.4	<b>700 MHz B13</b> 25.6	<b>800 MHz B5</b> 25.6	<b>1700 MHz B4</b> 26.7	<b>1900 MHz B2</b> 26.9
Power output for single cell phone (Downlink) dBm	4.8	4.8	4.8	4.6	4.5
Noise Figure	5 dB (nominal)				
Isolation	> 90 dB				
Power Requirements	12V 1.8A				

Each Signal Booster is individually tested and factory set to ensure FCC compliance. The Signal Booster cannot be adjusted without factory reprogramming or disabling the hardware. The Signal Booster will amplify, but not alter incoming and outgoing signals in order to increase coverage of authorized frequency bands only. If the Signal Booster is not in use for five minutes, it will reduce gain until a signal is detected. If a detected signal is too high in a frequency band, or if the Signal Booster detects an oscillation, the Signal Booster will automatically turn the power off on that band. For a detected oscillation the Signal Booster will automatically resume normal operation after a minimum of 1 minute. After 5 (five) such automatic restarts, any problematic bands are permanently shut off until the Signal Booster has been manually restarted by momentarily removing power from the Signal Booster. Noise power, gain, and linearity are maintained by the Signal Booster's microprocessor.

The term "IC" before the radio certification number only signifies that Industry Canada technical specifications were met. This device complies with Part 15 of FCC rules. This device contains licence-exempt transmitter(s)/receiver(s) that comply with Innovation, Science and Economic Development Canada's licence-exempt RSS(s). Operation is subject to the following two conditions: (1) This device may not cause interference, and (2) This device must accept any interference, including interference that may cause undesired operation of the device. Changes or modifications not expressly approved by weBoost could void the authority to operate this equipment.

## ✔ 2 YEAR WARRANTY

weBoost Signal Boosters are warranted for two (2) years against defects in workmanship and/or materials. Warranty cases may be resolved by returning the product directly to the reseller with a dated proof of purchase.

Signal Boosters may also be returned directly to the manufacturer at the consumer's expense, with a dated proof of purchase and a Returned Material Authorization (RMA) number supplied by weBoost. weBoost shall, at its option, either repair or replace the product.

This warranty does not apply to any Signal Boosters determined by weBoost to have been subjected to misuse, abuse, neglect, or mishandling that alters or damages physical or electronic properties.

Replacement products may include refurbished weBoost products that have been recertified to conform with product specifications.

RMA numbers may be obtained by contacting Customer Support.

**DISCLAIMER:** The information provided by weBoost is believed to be complete and accurate. However, no responsibility is assumed by weBoost for any business or personal losses arising from its use, or for any infringements of patents or other rights of third parties that may result from its use.

# we:boost



3301 East Deseret Drive, St. George, UT

 1-866-294-1660



[www.weboost.com](http://www.weboost.com)



[support@weboost.com](mailto:support@weboost.com)

Copyright © 2020 weBoost. All rights reserved. weBoost products covered by U.S. patent(s) and pending application(s)  
For patents go to: [weboost.com/us/patents](http://weboost.com/us/patents)

NOT AFFILIATED WITH WILSON ANTENNA

GDE000471\_002\_03.27.24